

RAYLI SİSTEMLERDE ÇÖZÜM ORTAĞINIZ

Trenturk Raylı Sistemler A.Ş.

info@trenturk.com

www.trenturk.com



HAKKIMIZDA

2010 yılında kurulduğumuz günden bu yana, ülkemizde gelişmekte olan raylı sistemler sektöründe; hızlı tren, metro, hafif raylı sistem ve yük trenleri ile raylı sistem altyapı hattı ve sinyalizasyon projelerinde yedek parça, bakım-onarım-montaj, sarf malzeme, ray ekipmanları ve makineleri gibi geniş bir yelpazede çözümler üretmekteyiz.

İthalat-ihracat, gümrükleme ve lojistik faaliyetlerimizle de demiryolu sektörünün ihtiyaçlarını karşılamaktayız.

MİSYONUMUZ

Türkiye'de gelişmekte olan demiryolu ve raylı sistemler sektörünün ihtiyaçlarına çözüm üreterek gelişmesine katkıda bulunmaktadır. Raylı sistem işletmelerinin kesintisiz olarak hizmetlerine devam edebilmelerini sağlamak amacıyla, üreticiden doğrudan son kullanıcıya hızlı ve güvenli bir şekilde tedarik zinciri oluşturmak, yedek parça ve ekipman üretimine destek vermek, ithalatta gümrükleme ve lojistik konularında yardımcı olmaktır.

VİZYONUMUZ

Türkiye'deki raylı sistem altyapısı ve araçlarının karşılıklı işletilebilirlik standartlarına uygun hale getirilmesine katkıda bulunarak, dünya standartlarına ulaşmasını sağlamaktır. Ülkemizin her bölgesinde raylı sistemin ve demiryolunun en çok kullanılan ulaşım sistemi olmasına katkı vermektir.

ABOUT US

Since our establishment in 2010, in the developing railway systems business in Türkiye; We produce a wide range of solutions such as spare parts, maintenance - repair - installation, consumables, railway equipment and machines for high-speed trains, metro, light rail system and freight trains, as well as railway systems infrastructure line and signaling projects.

We also meet the needs of the railway sector with our import-export, customs clearance and logistics activities.

MISSION

To contribute to the development of railway systems business in Türkiye by providing solutions to their needs. In order to ensure that railway system operators and vehicle manufacturers can continue their services without interruption, to create a fast and safe supply chain directly from the manufacturer to the end user, to support the production of spare parts and equipment, and to assist in customs clearance and logistics issues in imports.

VISION

To contribute to the adaptation of the railway system infrastructure and vehicles in Turkey to interoperability standards and to ensure that they reach world standards. To contribute to making the railway systems the most used transportation system in every region of our country.

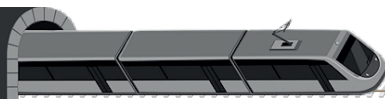

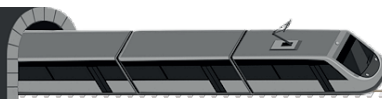

KONYA Büyükşehir Belediyesi - ŠKODA ForCity Trenleri Bakım/Onarım/Boyama Projesi 2019-2023
KONYA Metropolitan Municipality - Maintenance/Repair/Paint Project of ŠKODA ForCity Tramcars 2019-2023



KONYA Büyükşehir Belediyesi - Bisiklet Tramvayı Projesi 2020
KONYA Metropolitan Municipality - Bicycle Tramcar Project 2020



ANKARA EGO Genel Müdürlüğü - ASELSAN Ankara Metrosu Modernizasyon Projesi 2018
ANKARA EGO Dep. of Trans. Plan. and Rail System - ASELSAN Metro Ankara Modernization Project 2018



SAMSUN - CNR Trenleri Bakım/Onarım Projesi 2014-2016
SAMSUN - Maintenance/Repair Project of CNR LRS Vehicles 2014-2016



SAMSUN - AnsaldoBreda Sirio Trenleri Bakım/Onarım Projesi 2010-2013
SAMSUN - Maintenance/Repair Project of AnsaldoBreda Sirio LRS Vehicles 2010-2013





Lokomotif, hızlı tren, metro, tramvay ve yolcu vagonu gibi demiryolu üzerinde çeken veya çekilen araçların ve bu araçlara ait yedek parçaların lojistik ve gümrük hizmetleri konusunda 15 yılı aşan tecrübemizle hizmetinizdeyiz.

We are at your service with over 15 years of experience in the logistics and customs services of railway vehicles such as locomotives, high-speed trains, subways, trams and passenger wagons, and spare parts for these vehicles.

KOMPLE TREN SETLERİNİN LOJİSTİĞİ ve GÜMRÜKLEMESİ

LOGISTICS and CUSTOM CLEARANCE PROCESS of COMPLETE TRAIN SETS

KARAYOLU TAŞIMACILIĞI
INLAND TRANSPORTING



HAVAYOLU TAŞIMACILIĞI
AIRWAYS TRANSPORTING



LOWBED TRUCKS



Antonov An-225 AIRCARGO



DEPOLAMA ve TEDARİK ZİNCİRİ YÖNETİMİ
STORAGE and SUPPLY CHAIN MANAGEMENT



DENİZYOLU TAŞIMACILIĞI
MARITIME TRANSPORTING



GARANTİ KAPSAMINDAKİ YEDEK PARÇALARIN TAMİRİ / DEĞİŞİMİ AMACIYLA GEÇİCİ İHRACATI
SENDING SPARE PARTS UNDER WARRANTY TO THE MANUFACTURER FOR REPAIR OR REPLACEMENT

TAMİR EDİLEN / DEĞİŞTİRİLEN YEDEK PARÇANIN VERGİDEN MUAF OLARAK İTHALATI
IMPORT OF REPAIRED / REPLACED SPARE PARTS WITHOUT TAX

RAYLI SİSTEM ARAÇLARI YATIRIM TEŞVİK ve GÜMRÜK MUAFİYET DANIŞMANLIĞI
CONSULTING of CUSTOM DUTIES EXEMPTION and INVESTMENT INCENTIVE of RAILWAY SYSTEM VEHICLES



EMD (GM) 16-645E3-C

EMD / GM 645 - 710

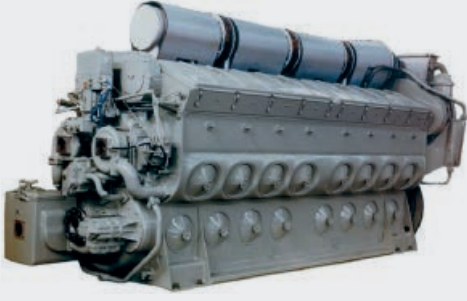

5229288
Enjektör Tamir Takımı



40021330
Silindir Başlığı



8262903
Karter Yağı Pompası



1115567
Marş Otomatığı



8206553
Flanş Yatak



8369675
Yatak



8039671
Regülatör Tahrir
Dişli Yatağı

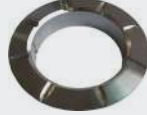

8369674
Baga



8069157
Baga



8379914
İşlenmemiş
Alın Yatağı



8028466
Alın Muhafazası



8472778
Piston



40115789
Piston



8085254
Boşluk
Ayarlayıcı



9547101
Nozzle Ring



40060841
Biyel Kolu Çatal



8028006
Krank Mili Alın Yatak



8354118
Üst Kol Yatak



8237900
Kam Mili Yatak



8071176
Kam Mili
Orta Yatak



8253825
Kam Mili
Arka Uç Yatak



8455844
Ana Yatak

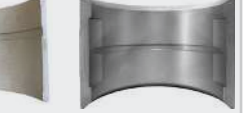

8136114
Küresel Yatak

MTU-8V-396-TC13

MTU 8V - 12V - 16V

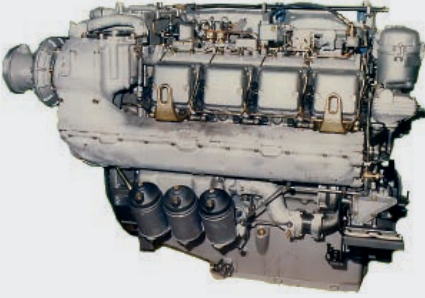

0020204100
Turbo Kompresör



8695860176
K37 Turbo Repair Kit



8690960027
Turbo Egsoz Rotoru



5550105141
Silindir Başlığı



0001536020
Deuta Werke
Devir Dinamosu



8690740021
Mazot Pompa Elemanı

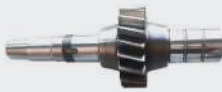

5552010005
Su Pompa Mili



5500530401
Emme Subabı



0433 220 163
Bosch DLL 152 S 780
Enjektör Memesi



0010170712
Bosch 950 DLL 152 S780
Enjektör Memesi



8699930011
Bosch 2 434 619 047
Enjektör Baskı Yayı



0002017519
Mekanik Salmastra



5501800016
Yağ Filtresi



000921705
Yakıt Filtresi



0021883601
Yağ Soğutucu



5500160121
Külbütör Lastiği



5502010280
Su Pompa Contası



005 250 1101
Elastik Kaplin



000471035000
Segman



0040372419
Segman

PERKINS APU



2644H203
Yakıt Enjeksiyon Pompası



U5MW0194
Devirdaim Pompası



2645K012
Enjektör



2868A006
Hız Sensörü



4133L508
Termostat



9702-FDR
Yakıt pompası



26420469
Yakıt Selenoid Valf



U5MK0650
Elektronik Regülatör



VDO 360-081-032-052C
Yağ Basınç Müşürü



CUMMINS



3400698
Şarj Alternatörü



2897691-3056344
Basınç Anahtarı



5292708
Termostat



5263314
Enjektör



3050692
Manyetik Anahtar



3631241
Piston Kiti



3803529
Ekzoz Sübap



4089500
Segman Kiti



3408282
Silindir Başlık



3071085
Su Pompa Contası



206948
Su Pompası Yağ Keçesi



3081895
Kulbütör Kolu Muhafaza Contası



3634664
Silindir Kapak Contası



3002834
Eksantrik Yatağı



205840
Biyel Kol Yatak



AR12270
Komple Ana Yatak

DELCO REMY



10479124
Marş Motoru



830620
Marş Motor Kavrama Dişlisi



1115717
Bendiks Bobini



10469239
Endüvi



1945848
Kapak



1945853
Alan Sargısı



1967345
İkaz Sargısı



1967354
Fırça Plakası



1894637
Burç Büyük



1894635
Burç



1945484
Marş Motor Manivela



1965472
Marş Motor Bağası

MOTOR - REDÜKTÖR - POMPA - KOMPRESSÖR



ACD 025L6 NVBP
Yakıt İkmal Pompası



MC 6X-404928
Yakıt İkmal Motoru



BOCK HGX5-725-4 S
Kompresör



BOCK HGX22P 190-4
Kompresör Klima



DORIN H750CS
Kompresör



MARCO UP2-P 16420213
Dişli Pompa



GALI 191544D
Havali Marş Motoru Selenoidi



BOSCH 0 001 510 003
Marş Motoru



ENGEL GNM 5480
DC Motor Fren sistemi HPU



3E100L4D M23C
Dişli Redüktör

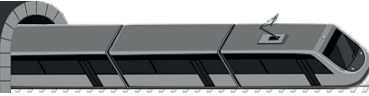

BOJİ PARÇALARI
BOGIE PARTS

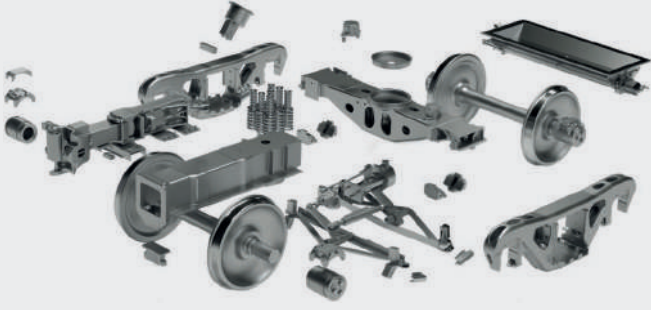

Kayma Plakaları



K Tipi Kompozit Sabo - Fren Pabucu



İkincil Süspansiyon



Yatay ve Dikey Damper

TEKERLEK
WHEEL



Monoblok Tekerlek
BA 004 - BA 318
Ø 920 mm



Bandajlı Tekerlek

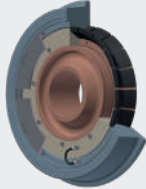

Tekerlek Bandajı

RULMAN
BEARING



EMD 908410
SKF BB1-1632



EMD 40036564



EMD 40036565



TIMKEN X32014X



SKF NU 208 ECML-C3



SKF NU 1014 ECP



SKF NUP 210 ECM

TAMPON
CRASH BUFFER



CER PAKETİ - CER KANCASI - KOŞUM TAKIMI
DRAW GEAR - COUPLING HOOK - SCREW COUPLING

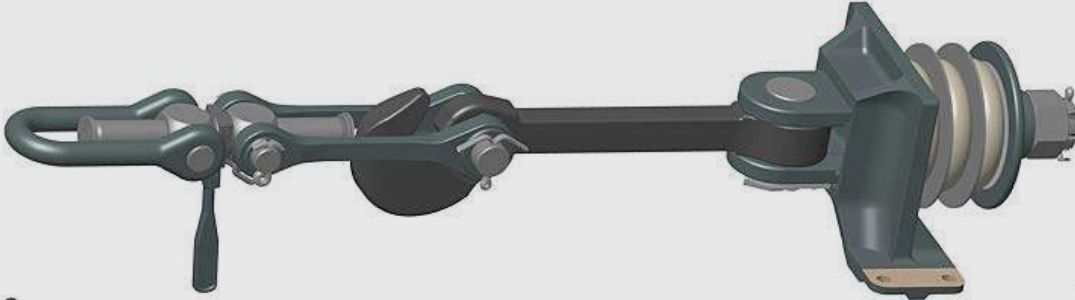

VİDALI KOŞUM TAKIMI



CER KANCASI



CER PAKETİ

TALAŞLI ve KAYNAKLI İMALAT İŞLEMLERİ
MACHINING AND WELDING MANUFACTURING PROCESSES



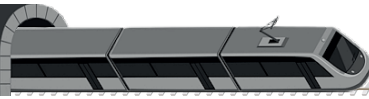

DEVRE KESİCİ
CIRCUIT BREAKER



KONTAKTÖR
CONTACTOR



YARDIMCI KONTAKT
AUXILIARY CONTACT





AKIM ve VOLTAJ SENSÖRÜ
CURRENT and VOLTAGE SENSOR



ABB
CS2000BR
Akım Sensor



ABB
ES1000C
Akım Sensor



LEM
LTC 350-S
Akım Sensor



LEM
LTC 600-S
Akım Sensor



ABB
VS1000B
Voltaj Sensor



LEM
LV 100-2000-SP6
Voltaj Sensor



LEM
DVL 1000
Voltaj Sensor

IGBT MODÜL
IGBT MODULE



SEMIKRON
SKM200GB12T4



SEMIKRON
SKM200GB173D



SEMIKRON
SKIIP 613 GD123-3DUL



SEMIKRON
SKIIP 1814 GB17E4-3DUL



ABB
5SND 0800M170100



INFINEON
FZ1500R33HE3



MITSUBISHI
PM75RL1A120



MITSUBISHI
PM150RL1A120

DC/DC KONVERTÖR
DC/DC CONVERTER



MURATA PS
NTA0515MC



RECOM
RK-2405S-P

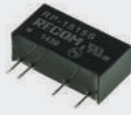

RECOM
RP-1515S



RECOM
RP-2415S-P



TRACO POWER
TEN 5



BEL POWER
1101MX35 D12D12-8



SYNQR
IQ1B050QC618NRS-G



COSEL
DBS400B24



BELPOWER
RCM 150-300



POLYAMP
PM50C60-60



MEANWELL
RSD-150D-12

KAPASİTÖR
CAPACITOR



VISHAY
PEC KMKP-100IBR



ZEZ SILKO
PVAJP 970 - 1-1000



ZEZ SILKO
PVDJP 21-6,8-0,33



ZEZ SILKO
PODJV 1

ETHERNET / AĞ BİRİMLERİ
ETHERNET - WEB UNITS



MOXA TN-5308-LV
Ethernet Switch



AMIT RRU-WC-1101
WTb - CAN Ağ Geçidi



HUAWEI
ME909s-120
LTE Module



HMS Networks
1.01.0281.11001 IXXAT



Advantech
EKI-5626CI-AE
Ethernet Anahtar



SIM 7100 E
PCIe LTE Modül



SCHNEIDER M241 TM241CE24T
Transistör Ethernet



TE Connectivity
TES Serisi
Ethernet Anahtar

DiĞER ŞALT ÜRÜNLERİ
OTHER AC/DC PRODUCTS



BOSCH - 0 192 033 004
Şarj Regülatörü



DOLD - BA9053
Varimeter



Leroy-Somer
R450 Voltaj Regülatörü



MOELLER-EATON
512-DC-RCX
Zaman Kartı



SCHNEIDER - A9N26476
Şönt Açma Bobini



ABB - ACS310-03E-17A2-4
LV AC Sürücü



PEPPERL FUCHS
KF8-UFC-Ex1.D
Frekans Dönüştürücü



ELİMKO - E700-3-1-0-1
Sinyal Çevirici

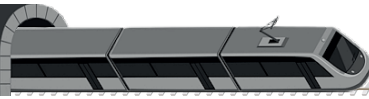

RÖLE RELAY

FINDER



46.52.9.110 46.52.9.024 7S.16.9.110 7S.16.9.024 7S.36.9.024



94.04.7.SMA Soket 97.52.7.SMA Soket 97.P2.7.SMA Soket

AMRA



RCGR12 RDGR12 RDGR76-C072 PAIR160 Soket

MORS-SMITT



AG 400 CM 009 24 9B S U201-L D-U204-W013 MTDV4 TDBE4-U201 V23 Soket



ABB E290-16 ABB TF42-35B ABB RD3 BOSCH 0 331 801 300 BOSCH 0 331 802 005 BOSCH 0 333 006 006 OMRON G2R-1-SNI OMRON G2R-2-SNI RELPOL MT-W-17S SCHNEIDER LR3D356

SİGORTA FUSE



D120GC75V50EF D120GC75V125EF D120SC20C125QF D120SC20C125QF PC32UD69V630D1A PC70UD13C125D1A PC73GB69V630D1A PC73UD10C1000TF

FERRAZ SHAWMUT - MERSEN



FD20GB100V10T FD20GC100V40T A720T2E-1 FR10GR69V16 R1027057 NH000AM69V20 3TF05014 NH2UD69V630PV



525I-NB.250 525I-NB.630 Cam ve Seramik Sigortalar STOPCIRCUIT GN-GV-GD Serisi

SENSÖR SENSOR



LENORD BAUER GEL 247 Boji Hız Sensörü OMRON E52-P15AY-NETU 8M Yangın Sensörü HEINZMANN IA02-76 Pick-up Sensor RED LION MP62TA00 Manyetik Pick-up HIOKI 9750-01 Yalıtım Test Probu JUMO MIDAS S05 Basınç Transmitteri NORGREN M-40-2 Piston Sensörü BALLUFF LR50067 Seviye Sensörü KOBOLD NKP 1501 Seviye Cihazı HONSBURG UB1-032EM Yağ Akış Sensörü BEDIA CLS-40 Yağ Seviye Sensörü SICK VL18-4P3212 Fotoelektrik Sensör DATALOGIC S3Z-PR-5-B01-PD Minyatür Fotosel DATALOGIC S6R-5-C200-P Kompakt Fotosel JUMO 902030 PT100 Sıcaklık Sensörü JAQUET DSE EH20 Motor Hız Sensörü LENORD BAUER GEL 2161 Rulman Sıcaklık Sensörü KIDDE-FENWAL 01-017102-000 Termoswitch MINCO S11016PD Sıcaklık Sensörü ASAHI KEIKI US-118BYL ON 76C Termostat

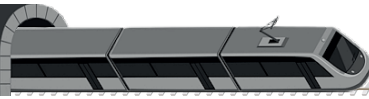

BUTON ve ANAHTAR

BUTTON and SWITCH

TSL ESCHA



EAO



RAFI



BOSCH 0 342 311 003
Anahtar



704.405.018



704.510.000



61-6441.4057



704.151.892

SCHALTBAU



Master Controller

S579
Deadman Button



PDA1 Totman Pedali



704.900.3



61-8006.01



10-2J13.1064



704.151.892



SCHNEIDER XPEM111 Pedal



KRAUS NAIMER
C42 TR4702



KRAUS NAIMER
CH11



BTC ED-3044P3
Dimmer



FESTO EI Kumandalı Valf

GÖSTERGE

INDICATOR



CUMMINS
3015232
Yağ Basınç

CUMMINS
3015234
Su Sıcaklık

CUMMINS
3031734
Motor Devir

CUMMINS
3035766
Motor Çalışma Saati

DEUTA WERKE
EF 66.20.16
Devir

EMD
8295501
Ammeter

EMD
9565441
Cer Motor Amper

EMD
9563280
Cer Motor Amper

KORNA ve İKAZ CİHAZI

HORN and BUZZER



MARCO K2

MARCO TM80-N

SEGER 45CK24.000.02K

SANEL SB888

SONALERT SC628P

HITPOINT PF-35A29ER

SCHALTBAU JA222D

AYDINLATMA

ILLUMINATION



HELLA
2PS 007 943-011

HELLA
2PS-964-295-081

HELLA
2BA 002 652-111

HELLA
2PF-959-590-307

HELLA
2JA 343 700-051

SEC
Kapi Eşiği LED Spot

SEC
UNILED-G LED

HELLA
2SB 009 362-3

HELLA
2SB-009-362-307

HELLA
2NE-009-001-021

HELLA
2ZR 009 001-011

HELLA
2BA 009 001-411

HELLA
1N0 008 582-017

WA0007
KAPI ÜSTÜ İKAZ

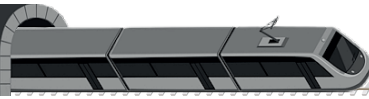

KABLO CABLE



3GKW single core



A2YL2YB2Y



FLAMEX(N)HXAF

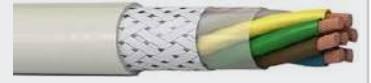

LIHCH



NSGAFÖU



NSSHÖU



P-2Y2YB22Y



BOJİ TOPRAKLAMA

KONNEKTÖR CONNECTOR

AMPHENOL



97B4106SQ325P



AHDM04-18-21PN



PT02SE16-8P



AHDM06-18-21SN



PT06SE16-8SSR

HARTING



09150043113



21038811430



21038212505



21038122505

ITT CANNON



CA06COM-E10SL



CA3108E10SL



MS3106E14S-6P



CA3108R10SL



KPSE06F12-3S



ABB 4125P6W



BOSCH 1928 403 874



GLENAIR IRT



KUKDONG KDB06E 14S-6S



LEMO FFP.2S.304.CLAC52

RADYAL ve EKSENEL FAN RADIAL and AXIAL FAN



EBM-PAPST
G2E108-A6G3-01



HELIOS
HQD 400/4/2 SA Bahn



ZIEHL-ABEGG
RH31M-2DK.31.2R



ZIEHL-ABEGG
RH25M-2DK.3B.1R

KARBON KÖMÜR CARBON BRUSH



TRENTURK
EG387 8X12X22



TRENTURK
CG651 6.2X8X14



STEMMAN
305902

TRENTURK
TK101121



MORGAN
EMD 40047197



MORGAN
EMD 8413191



40x20x50
TOPRAKLAMA KÖMÜRÜ

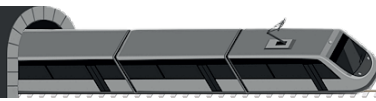

KLÜBERSYNTH GE 4 75 W 90	Dişli Kutusu
KLÜBERSYNTH GE 4 80 W 140	Dişli Kutusu
BARRIERTA L 25 DL	Kapı Plastik ve Elastomer
KLÜBERSYNTH BHP 72-102	Cer Motoru Rulman
KLÜBERBIO ALO 32-4000	Demiryolu Makas
KLÜBERLUB BE 41-1501	Dişli Kaplin
STABURAGS NBU 30 PTM	Disk Fren
KLÜBERPLEX AG 11-462	Pabuçlu Fren
ISOFLEX TOPAS L 152	Elektrik Motoru Rulman



SYNTHETIC GEAR OIL 4 75W-90	Dişli Kutusu
DELVAC 1 GEAR OIL 75W-140	Dişli Kutusu
UNIVIS HVI 26	Fren Sistemi Hidrolik
MOBIL SHC 75W-90	Dişli Kutusu
MOBILITH SHC 007	Dişli Kutusu
MOBILUBE 1 SHC 75W90	Dişli Kutusu
MOBILGREASE XHP 222	Boji ve Şasi
MOBILGREASE XTC	Dişli Kaplin

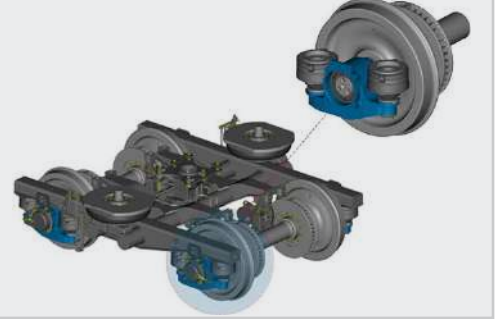

ECORAIL 8000 SERİSİ	Tekerlek Boden
ECORAIL 7000 SERİSİ	Kuplör ve Tampon Parçaları
BERUPLEX LI-EP 2	Rulman
BERUGEAR HV 10	Dişli Kutusu
BERUPLEX LG 1-30	Boji
BERULUB FR SERİSİ	Kapı ve Yolcu Kompartımanları
HYDROSTAR SERİSİ	Hidrolik Sistemleri
ECORAIL 5000 SERİSİ	Makas, Ray ve Kurplar

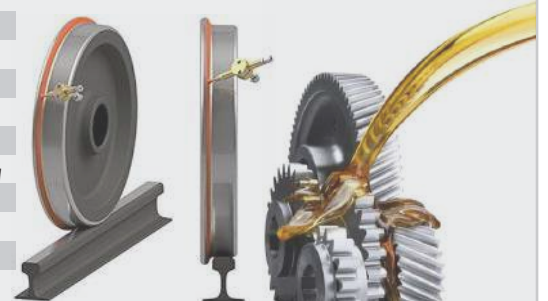

GLEITMO 585-K	Döner Halka ve Tabla
RENOLIN ZAF 32 XHV	Fren Sistemi Hidrolik
LOCOLUB ECO	Tekerlek Boden
CEPLATTYN 300	Dişli Kutusu
RENISO TRITON SE 55	Klima Kompresörü
TRAM-SILENCE SERİSİ	Ray Üzeri Temizliği
TRAMLUB 384 G PLUS	Makas Bağlantıları
STABYL LT 50	Pantograf
GLEITMO 300	Kapı Contaları

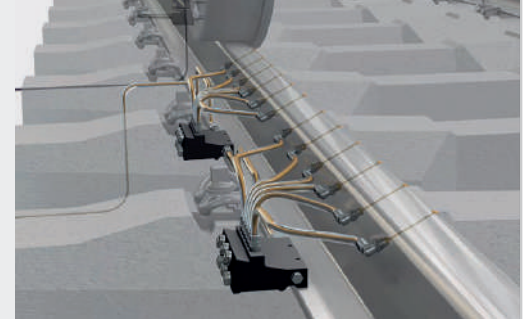

55 O-RING COMPOUND	Boji ve Çekiş Sistemi
3452 SILICONE GREASE	Pantograf ve Kuplör Sistemi
D PASTE	Kablo ve Klima Sistemi
CU-7439	Makas ve Altyapı Sistemleri
D-321R ANTI-FRICTION COATING	Motor Rulmanı ve Fren Sistemi
G-N PLUS PASTE	Fren Sistemi ve Dişliler
G-RAPID PLUS PASTE	Fren Sistemi ve Dişliler
111 COMPOUND	Boji ve Çekiş Sistemi
BR-2 PLUS GREASE	Boji ve Çekiş Sistemi

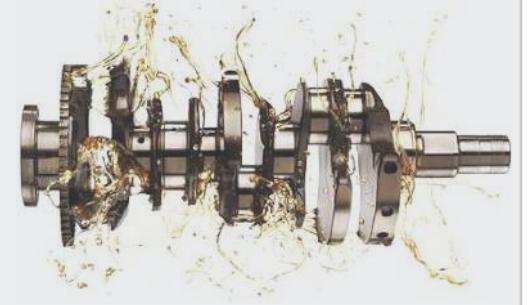

BUFFER GUARD	Tampon
GREASE HD 2	Kuplör
FIN GEAR ADDITIVE	Dişli Kutusu
PASTE HT1200	Boji Bağlantı
FOOD GREASE S1/2	Kapı Plastik ve Elastomer
GREASE OG	Pantograf ve İzolasyon
LUBE EPR	Makas Motoru ve Cebire
LUBE TF	Kapı Sistemi



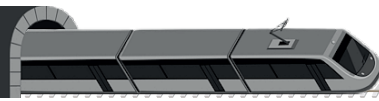

AUTOL TOP 2000



SHELL GADUS RAIL S3



TECTYL 506



FRIDEX EKO EXTRA



KILFROST K400



XIAMETER PMX 200



KYODO YUSHI
UNIMAX R NO.2



BASF GLYSCORR
693 GREEN



FAG ARCANOL
TEMP 110



FAG ARCANOL
VIB3



LUBCON SINTONO
TERRA SK



TEXOL GREASE
CAS-M000 PLUS



SHELL TELLUS
HİDROLİK GRESİ



SHELL OMALA
DIŞLI GRESİ



SHELL CORENA
KOMPRESÖR GRESİ



SHELL MORLINA
SİRKÜLASYON GRESİ



SHELL GADUS
AĞIR YÜK GRESİ



SHELL SPIRAX
ŞANZİMAN GRESİ



SKF LGMT 2



SKF LGMT 3



SKF LGWA 2



SKF LGHP 2



SKF LGLT 2



MOLYSLIP
COPASLIP



NIEL-SEAL
JOINT SEALING COMPOUNDS



BRUGAROLAS
BESLUX



CASTROL MOLUB-ALLOY
PASTE WHITE



CASTROL
HYPIN AWS



ELECTROLUBE HTC



LUBRIPLATE
630-930



SİKAFLEX 268
POWER CURE



DOW CORNING
DC 4



TEROSON
PU 8550



TEROSON
MS 9399 BK



LOCTITE
SF 7471



LOCTITE
SF 7063



SCOTCHCAST
3M EASY 250



ARDROX
AV SERİSİ



İKV FILMSEC
1010

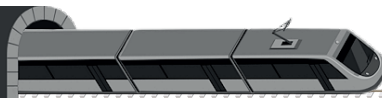

MEKANİK BODEN KUMPASI
ANALOGUE WHEEL PROFILE WEAR GAUGE

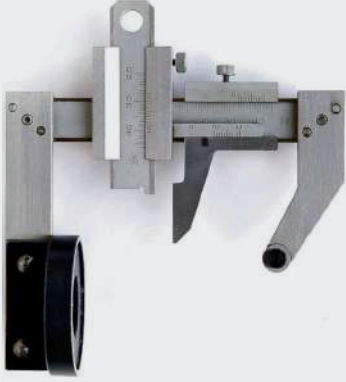

Boden Kalınlığı - Sd 15 ile 36 mm arası
Boden Yüksekliği - Sh 22 ile 36 mm arası
Boden Dikliği - Qr 6 ile 10 mm arası
Hassasiyet 0,1 mm

DİJİTAL BODEN KUMPASI
DIGITAL WHEEL PROFILE WEAR GAUGE

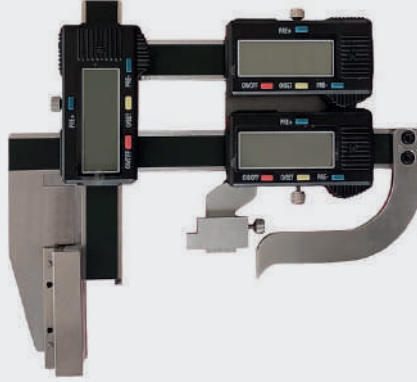

Boden Kalınlığı - Sd 20 ile 33 mm arası
Boden Yüksekliği - Sh -1 ile 9 mm arası
Boden Dikliği - Qr 5 ile 13 mm arası
Hassasiyet 0,01 mm

DİJİTAL ve MEKANİK UZUN ÇENELİ KUMPA
DIGITAL and ANALOG LONG JAW CALIPER

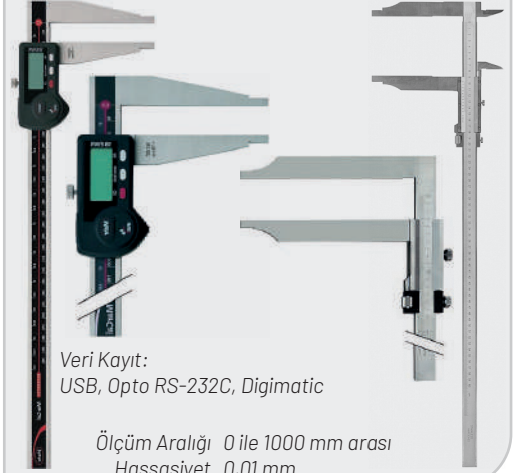

Veri Kayıt:
USB, Opto RS-232C, Digimatic

Ölçüm Aralığı 0 ile 1000 mm arası
Hassasiyet 0,01 mm

DİJİTAL TEKERLEK ÇAP ÖLÇÜM CİHAZI
DIGITAL WHEEL DIAMETER MEASUREMENT DEVICE



PDA - Bluetooth Ekran
Bluetooth Bağlantı
Kesintisiz 1000 adet ölçüm

Ölçüm Çapları min. 400, maks. 1400 mm
Ölçüm Sapması ±0.2 mm
Gösterge Ayracı 0.1 mm veya 0.01 mm
Ölçüm Pozisyonu S, mm 70mm, veya talebe göre
Temas Noktaları Aralığı (Ölçüm Çapları)
122 ±0.5 mm (400...750 mm)
200 ±0.5 mm (400...950 mm)
250 ±0.5 mm (600...1400 mm)
300 ±0.5 mm (720...1400 mm)



DİJİTAL TEKERLEK ÇAP ÖLÇÜM CİHAZI
DIGITAL WHEEL DIAMETER MEASUREMENT DEVICE



Ölçüm Çapları min. 400, maks. 1400 mm
Ölçüm Sapması ±0.2 mm
Gösterge Ayracı 0.1 mm veya 0.01 mm
Ölçüm Pozisyonu S, mm 70mm, veya talebe göre
Temas Noktaları Aralığı (Ölçüm Çapları)
125 ±0.5 mm (400...700 mm)
200 ±0.5 mm (400...950 mm)
250 ±0.5 mm (700...950 mm)
250 ±0.5 mm (700...1400 mm)

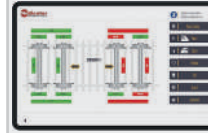

Opsiyon yazılım ile
tablette kullanılan
arayüzü görüntüsü

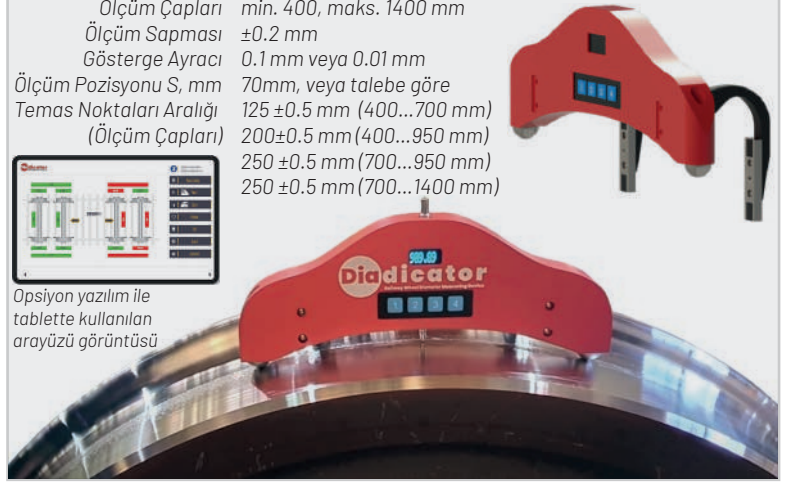

DİJİTAL TEKERLEK PROFİL ÖLÇÜM CİHAZI
DIGITAL WHEEL PROFILE GAUGE



Li-Ion Batarya STANDART
5400 mAh

KISA - Tramvaylar için
2400 mAh

SUPER KISA - Harici Batarya
2400 mAh

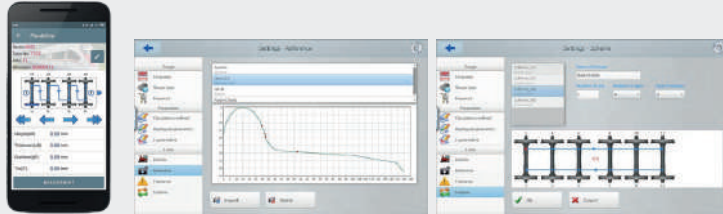

PDA -Bluetooth Ekran

PC ve PDA için Program



LASER WHEEL PROFILOMETER

Boden Kalınlığı - Sd 20 ile 50 mm arası
Boden Yüksekliği - Sh 20 ile 45 mm arası
Boden Dikliği - Qr 1 ile 15 mm arası
Bandaj Kalınlığı 36 ile 100 mm arası
Teker Çapı 400 ile 1400 mm arası
Hassasiyet 0,01 mm
Hata Sapma Payı ± 0,1
Ölçüm Süresi 4 saniye ortalama

DOLU ve BOŞ AKS ULTRASONİK MUAYENE TEST CİHAZI
PHASED ARRAY ULTRASONIC FLAW DETECTOR

Ekran Color TFT, 1024x 768
Hafıza 4 - 16 GB (40000 A-Tarama)
Phased Array Kaynak Tarama Yazılımı



Prob Çeşitleri

FREN SİSTEMİ TEST CİHAZI
BRAKE SYSTEM TEST EQUIPMENTS



UIC 540 & 543 standardı
Laptop ve Wireless Bağlantısı
ile Kolay Kontrol
Fren Panelini Trenden Sökmeden
Test Etmeye Elverişli



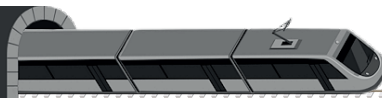

ANALOG EKARTMAN ve DEVER ÖLÇÜM ALETİ
ANALOGUE TRACK and SWITCH
GAUGE and SUPERELEVATION MEASURING DEVICE



1415 - 1475 mm Hat Açıklığı
-30 ile +200 mm Dever Yüksekliği
30 - 82 mm Flanş Aralığı
1385 - 1405 mm Kontra Ray Açıklığı
1345 - 1361 mm Dıştan Dışa Hat Açıklığı

DİJİTAL EKARTMAN ve DEVER ÖLÇÜM ALETİ
DIGITAL TRACK and SWITCH
GAUGE and SUPERELEVATION MEASURING DEVICE



180° Dönebilir Ekran

4 Satır Göstegeli Dijital Ekran

1384-1470 mm Hat Açıklığı
1364-1450 mm Kontra Ray Açıklığı
1344-1430 mm Dıştan Dışa Hat Açıklığı
-200~+200 mm Dever Yüksekliği
20-107 mm Flanş Aralığı
0.1 mm Hassasiyet



GEOSP JEODEZİK RAY MERKEZİ ÖLÇME ALETİ
GEOSP TRACK CENTER GAUGE

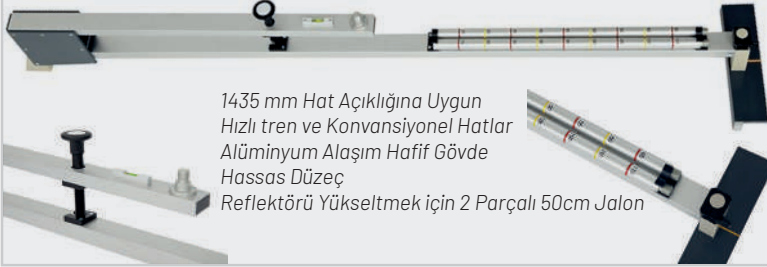

1435 mm Hat Açıklığına Uygun
Hızlı tren ve Konvansiyonel Hatlar
Alüminyum Alaşım Hafif Gövde
Hassas Düzceç
Reflektörü Yükseltmek için 2 Parçalı 50cm Jalon

RAY MASTARI - DÜZ ve ÇENTİKLİ
RAIL STRAIGHT EDGE GAUGE

Kalibrasyon TÜRKAK
Standart DIN 874
Boyut 1000 x 60 x 12 mm
Malzeme Çelik



SENTİL MASTARI
FLEER GAUGE
0,05 - 1 mm
20 parça bıçak

**RAY BAĞLANTI
ARALIK ÖLÇER**
RAIL JOINT
GAP GAUGE
0 - 30 mm



ULTRASONİK TEK RAY HATA DEDEKTÖRÜ

**ULTRASONIC SINGLE
RAIL FLAW DETECTOR**



UDS2-77 AREMA Prob Ünitesi
11 Prob Sayısı
0° / 4 MHz, ±70°, ±40/45°, ±50° SL / 2 MHz Prob Tipleri ve Frekansları
4 km/saat hız ile 1mm Tarama Aralığı
5 litre Kuplaj Tankı

RAY ve HAT GEOMETRİSİ SÜREKLİ KAYIT CİHAZI
CONTINUOUS DIGITAL RECORDING of TRACK GEOMETRY



Ölçüm Rotası Yerleşik GPS Alıcı
Ölçüm Raporları Anında PDF Format
Hat Açıklığı 1435 mm veya daha fazla (talebe göre)
Tablet 10" - IP65
Trackscan Uygulaması Ücretsiz (Google Play)
Hat Açıklığı -15 ile +50 mm arası
Dever ±200 mm
Bükülme ±200 mm
Gradyan 0'dan 65 mm'ye kadar
Yatay / Dikey Düzzensizlik ±5 mm / ±2 mm
Hafıza Kapasitesi 60.000 km

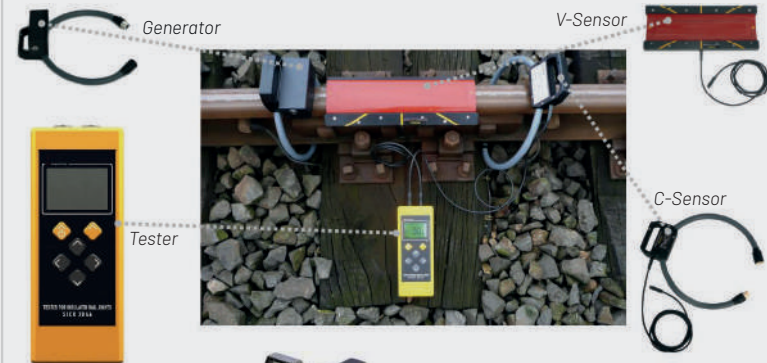
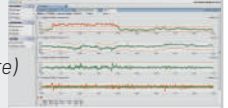

İZOLE CEBİRE TEST CİHAZI
TESTER FOR INSULATED RAIL JOINTS

Ölçüm Frekansı 28.6 kHz
Koruma Sınıfı IP 54
Direnç Ölçüm Aralığı 0 ile 50 Ohm arası (gösterge > 50 Ohm)
Ölçüm Toleransı +/- (20% + 1 rakam)
Çalışma Sıcaklık Aralığı -20°C ile +55°C arası
Ekran 128 x 64 Piksel, aydınlatmalı



RAY MANTARI AŞINMA KUMPASI
RAIL HEAD WEAR GAUGE
Dikey Aşınma 0 ile 15 mm
Yatay Aşınma 0 ile 15 mm
Hassasiyet 0,01 mm

OLUKLU RAY AŞINMA KUMPASI
GROOVED RAIL WEAR GAUGE
Dikey Aşınma 0 ile 15 mm
Yatay Aşınma 0 ile 15 mm
Hassasiyet 0,01 mm

MANYETİK RAY TERMOMETRESİ
MAGNETIC RAIL THERMOMETER
-40°C ile +70°C arası

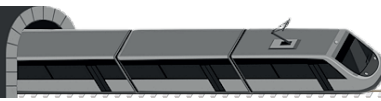

RAY DELME MAKİNESİ
RAIL DRILLING MACHINE

4 Zamanlı Motor Honda GX50
2,0 kW / 7000 rpm Motor Gücü
Ø9,8 mm den Ø42 mm' e kadar Delme Çapı
35 saniye Delme süresi
5 litre Sıvı Soğutma Tankı



RAY DELME UÇLARI
Materyal TCT Tungsten Carbide
Bağlantı Tipi Weldon Shank
18 ile 33 mm arası Delme Çapları
25 ile 50 mm arası Delme Derinliği



RAY KESME MAKİNESİ
RAIL CUTTING/SAW MACHINE

STIHL TS 800
Benzinli Motor
142 mm Maks. Kesme Derinliği
400 mm Maks. Disk Çapı
5,00 kW Motor Gücü
4600 rpm Maks. Dönme Hızı



RAY MENGENESİ
RAIL CLAMP



RAY KONNEKTÖRÜ ÇEKTİRME POMPASI
RAIL BONDING TOOL

700-1300 bar Çektirme Basıncı
46-31 kN Uygulama Kuvveti
24 mm Piston Boyu
10 mm Piston Çapı

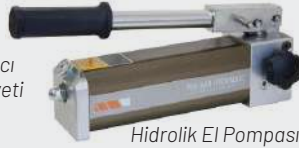

Hidrolik El Pompası



Hidrolik Hortum

Çektirme Pompa Başlığı



RAY KONNEKTÖR SETİ
RAIL CONNECTOR BOND KIT



M12 Kilitli Somun
Paslanmaz Çelik



M12 Düz Rondela
Paslanmaz Çelik



Kalay Kaplı
Bakır Kovan



M12 Konstruksiyon Pulu
Paslanmaz Çelik



M12 Çelik Cıvata
Gömme Altıgen Kafalı

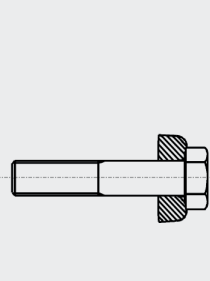

BURAJ MAKİNESİ
BALLAST TAMPING MACHINE

Tek kademeli - Pnömatik Motor
1,6 kW Motor Gücü
4.500 d/dk Motor Devri
55,0 J Darbe Enerjisi
Ø 27x80 mm Uç tutucu

WACKER NEUSON
BH55 RW



MAKAS ISITMA SİSTEMİ
SWITCH HEATING RODS

Makas Rayı Rezistansları
Makas Dili Rezistansları
Makas Motoru Rezistansları

Baston Tip



Düz Tip



RAY KALDIRMA EKİPMANI
RAIL LIFTING /GRABBING CLAMP

Bütün ray tipleri için uygundur.

Kaldırma Kapasitesi

Tekli 1000 kg
2000 kg
3000 kg

Çoklu 5000 kg
7000 kg
8000 kg



Çoklu Ray Kaldırma Seti



Tekli Ray Kaldırma Aparatı



DERAYMAN KÖPRÜSÜ
YENİDEN RAYA YERLEŞTİRME EKİPMANI

RERAILERS

9000 kN/aks Darbe Dayanımı



DERAIL

ÇİFT YÖNLÜ DERAY TAKOZU
CİVATALI TİP

DERAILER w/ TWO SIDE
BOLTED TYPE

9000 kN/aks Darbe Dayanımı



ÇİFT YÖNLÜ DERAY PABUCU
MAKAS MOTORU BAĞLANTILI

HINGED DERAIL
w/ SWITCH ROD CONNECTION

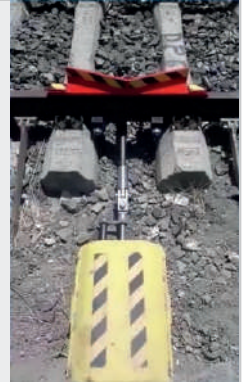

ÇİFT YÖNLÜ DERAY TAKOZU
DERAILER w/ TWO SIDE

9000 kN/aks Darbe Dayanımı



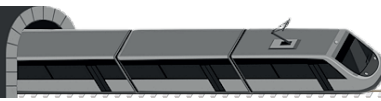

**CEBİRE
FISHPLATE**

49E1 Ray
UIC54 Ray
60E1 Ray

Deliksiz veya 2-4-6 Delikli
300-630 mm arası uzunluk

Teknik çizime göre özel kalıp üretimi



**CEBİRE İZOLASYON SETİ
INSULATED RAIL JOINT**

Özel yalıtkan reçine
İzole conta
Ray profili kesiti
Elektrik direnç: min. 30 MΩ



**CEBİRE MENGENESİ
TEMPORARY RAIL CLAMPS**



Yerli

Pandrol

Robel

Vortok

St 37 Çelik Malzeme
10.9 Kalite
M27x280 Bulon
UIC60, S49, S54, UIC54 Ray Tipleri



**SKL GERGİ KISKACI
SKL FASTENING SYSTEMS**

SKL 12-14-21 Gergi Kiskacı
SS 35 Tirfon
Uls 7 Pul
DWL 25 Dübel
WFP14K Açık Kilavuzu
EVA, EPDM Ray Altı Ped

Yüksek Hız ≥ 250 km/h
Konvansiyonel ≤ 250 km/h
Dingil Yüğü ≤ 26 Ton



**KPO TİPİ KRAPO
KPO TYPE RAIL CLAMP**

KPO3, KPO6, KPO9 Krapo
M 12 Krapo Bulonu ve Somun
M 12 Çift Yaylı Rondela
ST M22 x 65 Düz / Eğik Selet
EVA, EPDM Ray Altı Ped

Düz / Eğik Çelik Selet



**ÜÇÜNCÜ RAY TOPRAKLAMA ALETİ
3rd RAIL EARTHING GROUNDING EQUIPMENT**

Hat Rayı Temas Malzemesi Alüminyum Alaşım
3. Ray Temas Malzemesi Elektrolitik Bakır
Topraklama Kablosu Bakır-Kurşun, PVC
Germe Yayı Galvanizli Çelik
Bağlama-Sabitleme Parçaları Galvanizli Çelik
Çerçeve-İskelet Sentetik-Fiberglas

Elektriksel Kısa Devre Kapasitesi:
700 V DC - 750 V DC
Kısa Devre Akımı 30.5 kA - 100 kA
Süre 23 ms - 35 ms



**TOPRAKLAMA STANKALARI
INSULATING STICKS**

Teleskopik Stankalar

AC 15 kV - 25 kV
DC 750 V - 1500 V - 3000 V

Epoksi - Cam Elyaf Yalıtımlı Çubuk 3 veya 4 parçalı
Çaplar 28-33-37 ve 43 mm
Uç Bağlantı Universal - Altıgen
Açık Uzunluk 5 ile 10 metre arası
Maks. Gerilim 420 kV

Parçalı Stankalar

Toplam Uzunluğa Göre 2 - 7 parçalı
Toplam Uzunluk 2 - 6 metre
Güvenli Bağlantı Sistemi Ø 39 mm Çap

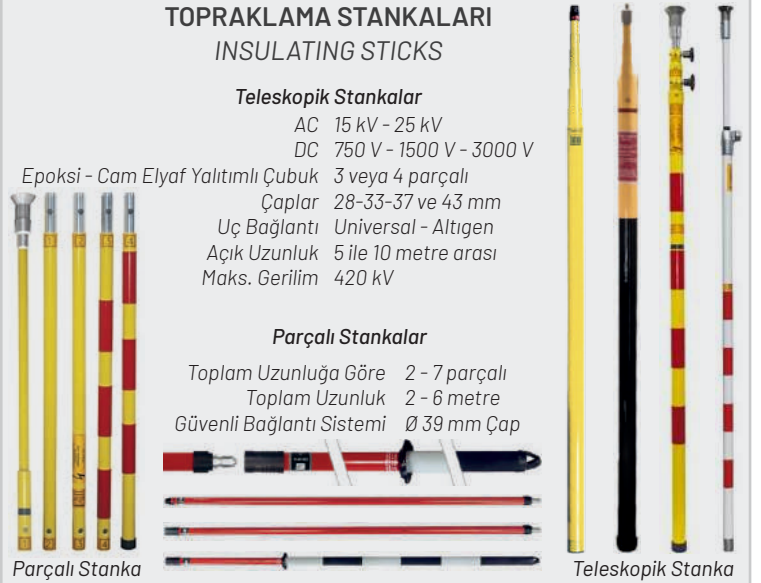

**KATENER TOPRAKLAMA KELEPÇELERİ
CLAMPS FOR SINGLE OR DOUBLE CATENARY**

Kovan Mili DIN 48 087
Bağlantı Somunu M10 - M12
Flanş ve Baskı Aparatı Bakır/Alüminyum Alaşım
Kalay kaplı
Ray Yalıtım 40 kA/1s
Maksimum Kablo Kesiti 150mm²



**TOPRAKLAMA KABLOLARI
EARTHING CABLES**

Bakır Kurşun Çok Esnek Tel
35 - 50 mm² Kablo Kesiti
PVC Dış Kaplama
4 ile 10 metre Uzunluk
12 mm Pabuç Delik Çapı
IEC-61230 Standardı
8 - 12 kA/1s Devre Anma Akımı



**RAY TOPRAKLAMA KELEPÇELERİ
CLAMPS FOR RAIL**

Ray Üstü Kelepçe
Alüminyum Gövde
Pirinç Kontak
Maks. 73mm Ray Mantarı

Ray Altı Kelepçe
Bakır Alüminyum Gövde
Sert Çelik Burgu Kelepçe
100 - 160 mm Ray Ayağı Genişliği



Ray Ayağı Kelepçesi
Kenetleme Genişliği
Ø 6-35 mm

Ray Miknatısı

Oluklu Ray Kelepçesi
Kısa Devre Akımı
8 kA/1s

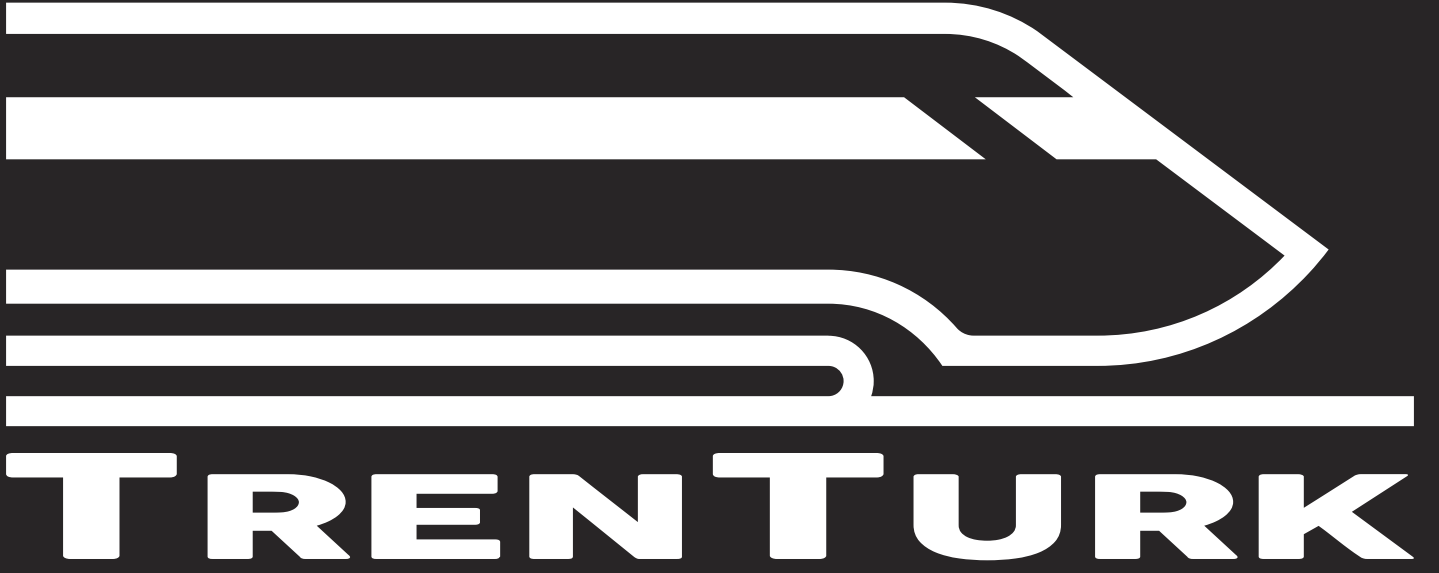

THE LIGHT AT THE END OF THE TUNNEL IS...



Trenturk Raylı Sistemler A.Ş.

SAMSUN

+90 532 303 71 03
+90 542 303 71 03
+90 552 303 71 03

+90 362 438 38 21

ANKARA

+90 312 750 01 79

+90 312 750 01 78

İSTANBUL

+90 212 963 19 30

+90 216 988 01 61



info@trenturk.com



Yenimahalle Mah. 3107. Sk. No: 1/B
55270 - Atakum / SAMSUN / TÜRKİYE



www.trenturk.com

 linkedin/trenturk

 instagram/trenturk

 twitter/trenturk

 skype/trenturk